

Version 3

May 4, 2020

Navigating What's Next: The Post-COVID Workplace

Product Guide : Screens

FORWARD
SPACE.

Steelcase[®]

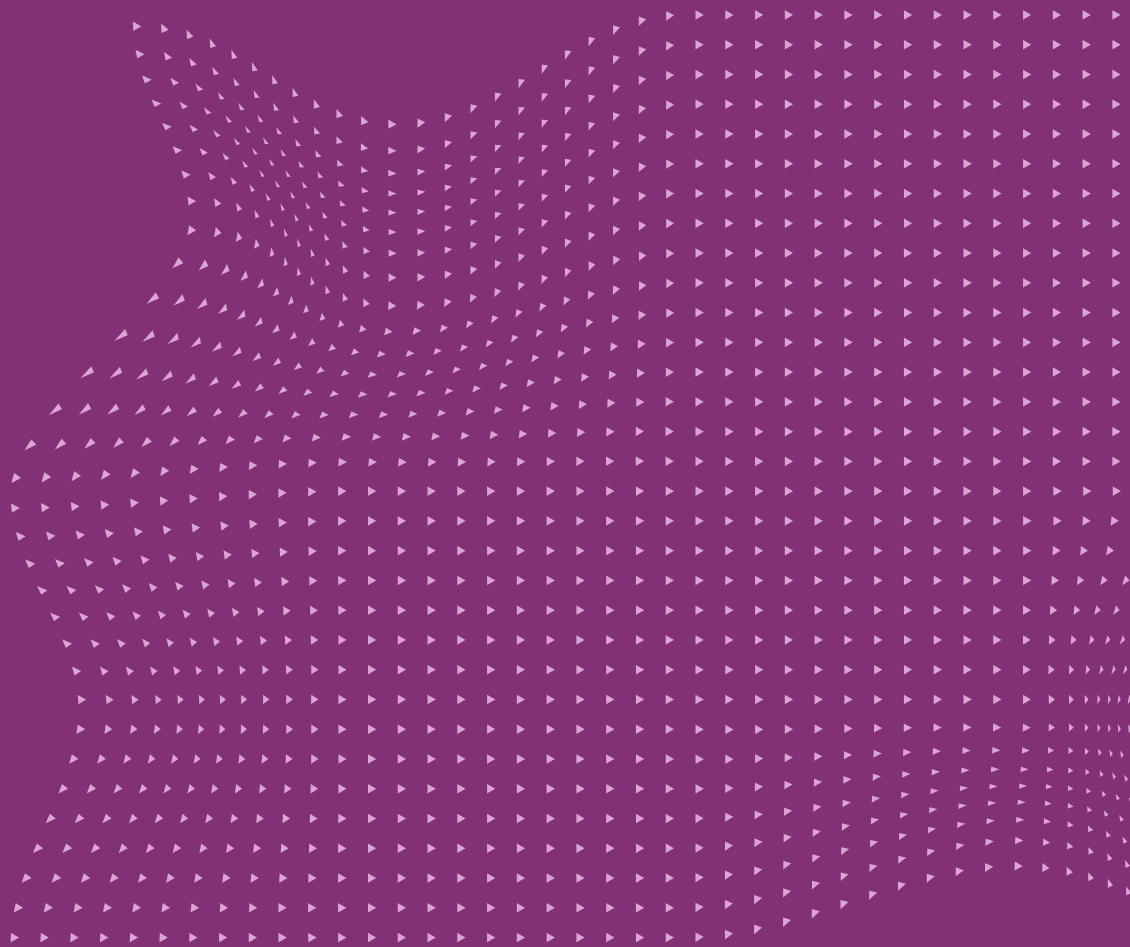

03

Using This Guide

04

Design Considerations

Retrofitting Workstations with Screens

05

Desking + Benching

16

Answer

30

Freestanding Screens

35

Appendix

— Materiality

— Available Product List

— Supporting Resources

— Flex Image Gallery

Using This Guide

This document is designed to supplement [*Navigating What's Next: The Post-COVID Workplace.*](#)

The *Navigating What's Next* guide offers strategies for retrofitting, reconfiguring and reinventing the workplace to create offices that are as safe as possible. It includes design guidelines and thought starters as well as safety guidelines.

In this document you'll find specific information on how to **retrofit screens** into existing work areas with immediately available products.

Design Considerations

Referencing *Navigating What's Next*, there are three key strategies to consider when retrofitting spaces now or reconfiguring in the near term are:

Density: the number of people per sq. ft/m

Geometry: how the furniture is arranged

Division: using screens, panels or barriers

These strategies should be used in combination to create spaces that, when supplemented with new safety guidelines, allow people to confidently come back into the workplace. Going forward, organizations will want to create a diverse range of spaces that are highly adaptable to allow them to navigate what's next.



Minimum Distance



Meet in the Open



More Owned Spaces



Re-orient Furniture



Separate Desks



Add Space Division



Moveable Screens



Height Helps

Retrofitting Workstations with Screens

Desking + Benching

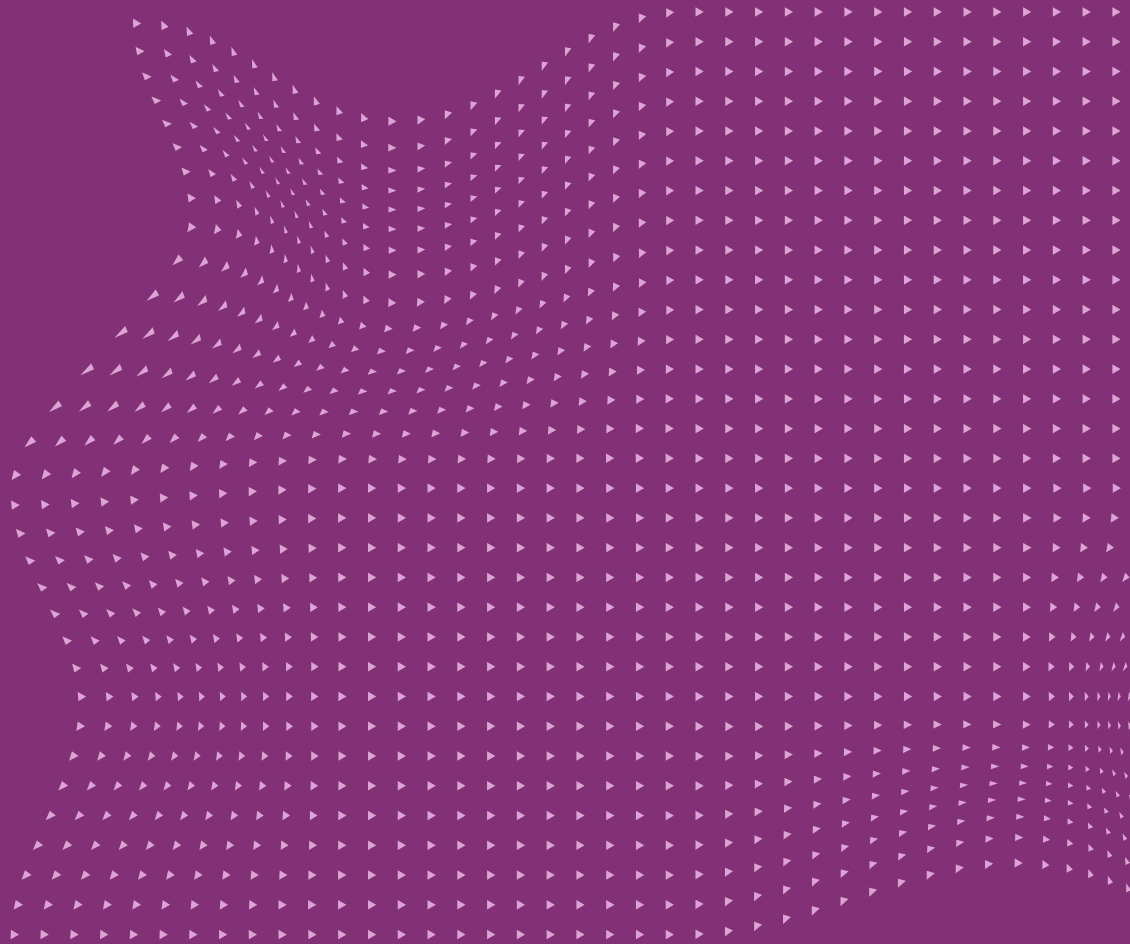

Steps to Retrofit Desking

1 Identify your workstation.



Migration SE



Migration



Ology



Flex Height-Adjustable Desk

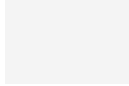

Other

2 Check for pinch point hazards. Steelcase recommends a 1" clearance on all sides of height-adjustable worksurfaces.

3 Determine the screening application that fits your need. Select from privacy screens, side screens or freestanding screens. Consider the following:

- Start by considering the Sarto, AMQ 3F or eSpecials glass side screen to meet post-COVID height and division requests.
- Complement existing back screens with side screens for additional shielding.
- Specify bleach cleanable fabrics or hard surfaces such as acrylic.
- Select height of screen based on desk layout and occupancy. Higher screens may be desired if employees are facing each other or are near circulation paths.
- Balance the need for shielding with the overall feeling of the workplace environment.

4 Once you have selected your screens, place your order.



Universal Privacy and Side Screens on Ology Desk

RESOURCES

[Height-Adjustable](#)

[Desks Specification Guide
\(Screens pg. 203\)](#)

Steps to Retrofit Benching

- 1 Identify your workstation.



FrameOne



Migration SE Bench



Ology Bench

- 2 Check for pinch point hazards. Steelcase recommends a 1" clearance on all sides of height-adjustable worksurfaces.

- 3 Determine the screening application that fits your need. Select from privacy screens, side screens or freestanding screens. Consider the following:

- Start by considering the Sarto, AMQ 3F or eSpecials glass side screen to meet post-COVID height and division requests.
- Complement existing back screens with side screens for additional shielding.
- Specify bleach cleanable fabrics or hard surfaces such as acrylic.
- Select height of screen based on desk layout and occupancy. Higher screens may be desired if employees are facing each other or are near circulation paths.
- Balance the need for shielding with the overall feeling of the workplace environment.

- 4 Once you have selected your screens, place your order.

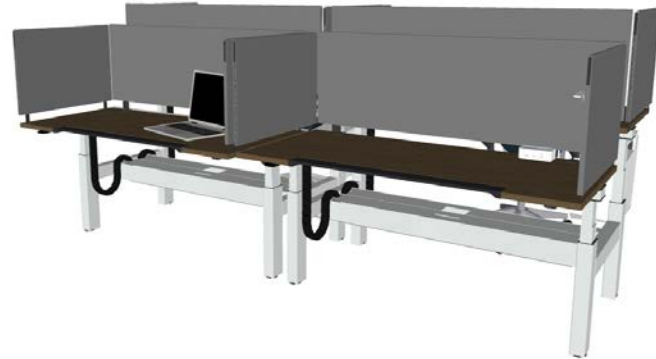

Universal Privacy and Side Screens on Ology Bench

Note: Offset brackets for side screens will be available for order in mid-May.

Note: if you require privacy screens that move with a height-adjustable worksurface, you will have to remove centered screens to avoid pinch point hazards.

RESOURCES

[Benching Specification Guide](#)

Sarto Privacy Screen

Works on	Ology Desk and Bench, Migration, Migration SE Desk and Bench, Flex, FrameOne, Series 5 worksurfaces, Elective Elements worksurfaces, Universal Tables and Universal panel-mount worksurfaces
Side screen	Yes
Height	Privacy 13.5"H, 19.5"H Privacy/Modesty 24"H (13.5" above surface)
Material	Fabric, <i>*Bleach Cleanable available</i>
Installation	Medium complexity
List price	\$431 – Privacy 60"W x 19"H \$466 – Privacy/Modesty 60"W x 24"H \$295 – Side 30"W x 19"H \$500 – Curved



Sarto Privacy/Modesty Screen on Migration SE



Sarto Privacy Screen on Migration SE



Sarto Curved Screen on Migration SE

Application Tips:

- Specify Sarto Privacy Screen (PSPS) to achieve tallest possible height (19.5" above surface).
Note: Privacy/modesty screens and curved screens cannot be used on height-adjustable benches. Specify privacy screen for use with height-adjustable benching. Centered screens and desk mounted privacy screens will violate pinch points if mounted together.
- Multiple sizes available for both sides and backs of worksurfaces.
- Screens are 5/8" thick. Take note when specifying screens back to back or side to side on worksurfaces.

RESOURCES

[Sarto Product Page](#)

Sarto Privacy Screen

New Standard Heights 24", 30" and 36"

Works on	Ology Desk and Bench, Migration, Migration SE Desk and Bench, Flex, FrameOne, Series 5 worksurfaces and Elective Elements worksurfaces
Side screen	Yes
Height	Privacy 24"H or 36" H Privacy/Modesty 24"H (17.5" above surface) Privacy/Modesty 30"H (24" above surface)
Material	Fabric, <i>*Bleach Cleanable available</i>
Installation	Medium complexity
List price	<i>Coming soon, FOE Targeted Mid-May 2020</i>



24" Sarto Privacy Screens on Flex Height-Adjustable Desk

Application Tips:

- New standard heights (24", 30", 36") provide more protection and privacy.
- New standard widths (29", 46", 58", 70") allow for a full wrap of the worksurface with Privacy or Privacy/Modesty Screens.
- 29"W side screen aligns with back screen (no gap between screens); new corner connection clip helps maintain 90° alignment.
- New offset bayonet bracket for 29"W Privacy Screen allows screen to mount within the footprint of the worksurface, helping to maintain pinch point clearances.
- Screens are 5/8" thick. Take note when specifying screens back-to-back or side-to-side on worksurfaces.

Universal Privacy Screen

Works on	Ology Desk and Bench, Migration, Migration SE Desk and Bench, Flex, Airtouch, FrameOne, Series 5 worksurfaces, Elective Elements worksurfaces, Universal Tables and Universal panel-mount worksurfaces
Side screen	Yes
Height	Privacy 13.5"H, 19.5"H Privacy/Modesty 26"H (13.5" or 19.5" above surface)
Material	Fabric, <i>*Bleach Cleanable available</i>
Installation	Medium complexity – 4 min, 2 people
List price	\$582 – Privacy 60"W x 19.5"H \$580 – Privacy/Modesty 60"W x 26"H \$399 – Side 30"W x 19.5"H

RESOURCES

[Universal Product Page](#)



Universal Privacy Screen
on Ology Desk



Universal Privacy/Modesty
Screen on Ology Desk

Application Tips:

- Specify Universal Privacy Screen (USPS) or Universal Privacy/Modesty Screen in Privacy configuration to achieve tallest possible height (19.5" above surface).
Note: Privacy/modesty screens and curved screens cannot be used on height-adjustable benches. Specify privacy screen for use with height-adjustable benching. Centered screens and desk mounted privacy screens will violate pinch points if mounted together.
- Multiple sizes available for both sides and backs of worksurfaces.
- Privacy/modesty screen is available in two configurations (13.5"H or 19.5"H of privacy above worksurface).
- Screens are 3/4" thick. Take note when specifying screens back to back or side to side on worksurfaces.

Acrylic Privacy + Modesty Screen

Works on	Ology Desk, Flex, Migration, Migration SE Desk and Airtouch
Side screen	Yes
Height	22" (19" above surface)
Material	Acrylic
Installation	Medium complexity – 4 min, 2 people
List price	\$512 – Privacy/Modesty 58"W x 19"H \$377 – Side Privacy 28"W x 19"H

RESOURCES

[Privacy + Modesty Screens](#) [Product Page](#)



Acrylic Privacy/Modesty
Screen on Ology Desk



Acrylic Side Screen on
Ology Desk

Application Tips:

- Available in multiple configurations including privacy only and privacy/modesty.
- Smaller widths can be used as sidescreens.
- Specify with or without cableway.
- Screens are 1" thick, overall (including brackets). Take note when specifying screens back to back or side to side on worksurfaces.

eSpecials Side Screen

Works on	3/4", 1-3/16" and 1-1/2" thick worksurfaces (FrameOne, Universal, Ology, Flex, Migration, Migration SE, c:scape and Elective Elements worksurfaces)
Dimensions	Width: 24" or 30" Height: 12" or 19.5"
Material	Glass
Installation	Medium complexity – 2 min, 1 person
List price	\$694 – 24"D x 19.5"H, Glass

RESOURCES

[eSpecials Library](#)



eSpecials Side Screen in glass on Ology Desk

Application Tips:

- Specify glass style (FMSSG) for greatest cleanability.
- Screens clamp onto front or back edge of worksurface.
- With glass screen, must be secured with screws to bottom of worksurface.
- Available in the eSpecials Library.

Steelcase Health Desktop Separation Screen

Works on	3/4" to 1-1/2" thick worksurfaces (FrameOne, Universal, Ology, Flex, Migration, Migration SE, c:scape and Elective Elements worksurfaces)
Dimensions	Width: 24", 30" or 48" Height: 30" or 42"
Material	Frame: Platinum Metallic (4799) Screen Panel: Smooth Clear Plastic or Smooth White Opaque Plastic
Installation	Low complexity
List price	<i>Coming soon, FOE Targeted Wednesday, May 6, 2020</i>



30"H and 42"H Desktop Separation Screens



Desktop Separation Screen on Groupwork Table

Application Tips:

- Developed by Steelcase Health as part of the Separation Screen statement of line.
- Constructed using the same highly cleanable plastic materials as the freestanding Separation Screens.
- Attaches to worksurfaces using a SOTO clamp to avoid damage.
- 6" x 12" cutouts allow for transfer of small items and enhanced acoustics.
- 24"W screens can also be placed on the sides of the desk for added barrier and safety.

AMQ 3F Screens

Works on	Worksurfaces between .5" and 1.625" thick
Side Screen	Yes
Height	18", 23" and 28" <i>Note: Height above worksurface is dependent on bracket selection.</i>
Material	PET
Installation	Low complexity – 5 minutes
List price	\$270 – 58"W x 23"H Linear \$410 – 58"W x 23"H x 23"D Wrapped L \$525 – 58"W x 23"H x 18"D Wrapped U \$60 – Top Mounted Bracket, Set of 2

RESOURCES

[3F Product Page](#)



Linear 3F Screen on ACTIV Desk using Sleeve Bracket



Wrapped L 3F Screen on ACTIV Desk using Top Mounted Bracket



Wrapped U 3F Screen on ACTIV Desk Using Privacy/Modesty Bracket

Application Tips:

- Linear, Wrapped L-Shape and Wrapped U-Shape applications available.
- Multiple sizes available for both sides and backs of worksurfaces.
- Wrapped screens can be mounted on top of the worksurface to avoid any creep or wrapped around the outside of the worksurface.

Note: Privacy/modesty screens cannot be used on height-adjustable benches. To support the use of side screens, specify a top mounted bracket. Centered screens and desk mounted screens will violate pinch points if mounted together.

- Multiple mounting bracket options available.
- Specify a top mounted bracket to achieve highest possible height of 28 ¾" above the worksurface.

Boundary Screens

Works on	Ology Bench, FrameOne
Dimensions	Width: Matches depths of the bench, with up to 18"W overhang Height: 28.5", 42", 48"
Material	Laminate, Veneer
Installation	Medium complexity – 15 minutes
List price	\$875 – 58"W x 48"H with 18"W Overhangs, Ology Bench \$524 – 28"W x 48"H with 18"W Overhang, Ology Bench \$886 – 60"W x 48"H Spanning with 18"W Overhangs, FrameOne \$529 – 60"W x 48"H Split with 18"W Overhangs, FrameOne



Boundary screen on FrameOne bench

Application Tips:

- Boundary screens for Ology Bench leverage existing holes in the cross tube making installation easy.
- Boundary screens for FrameOne require installers to stamp holes in the legs. Be aware that this is a permanent modification to the product
- Specify the tallest boundary screens with up to 18"W overhangs on each side to create the most protection at the end of a benchrun.
- Side screens can be used with boundary screens on Ology Bench *only* if they clear a 1" pinch point.

Retrofitting Workstations with Screens

Answer

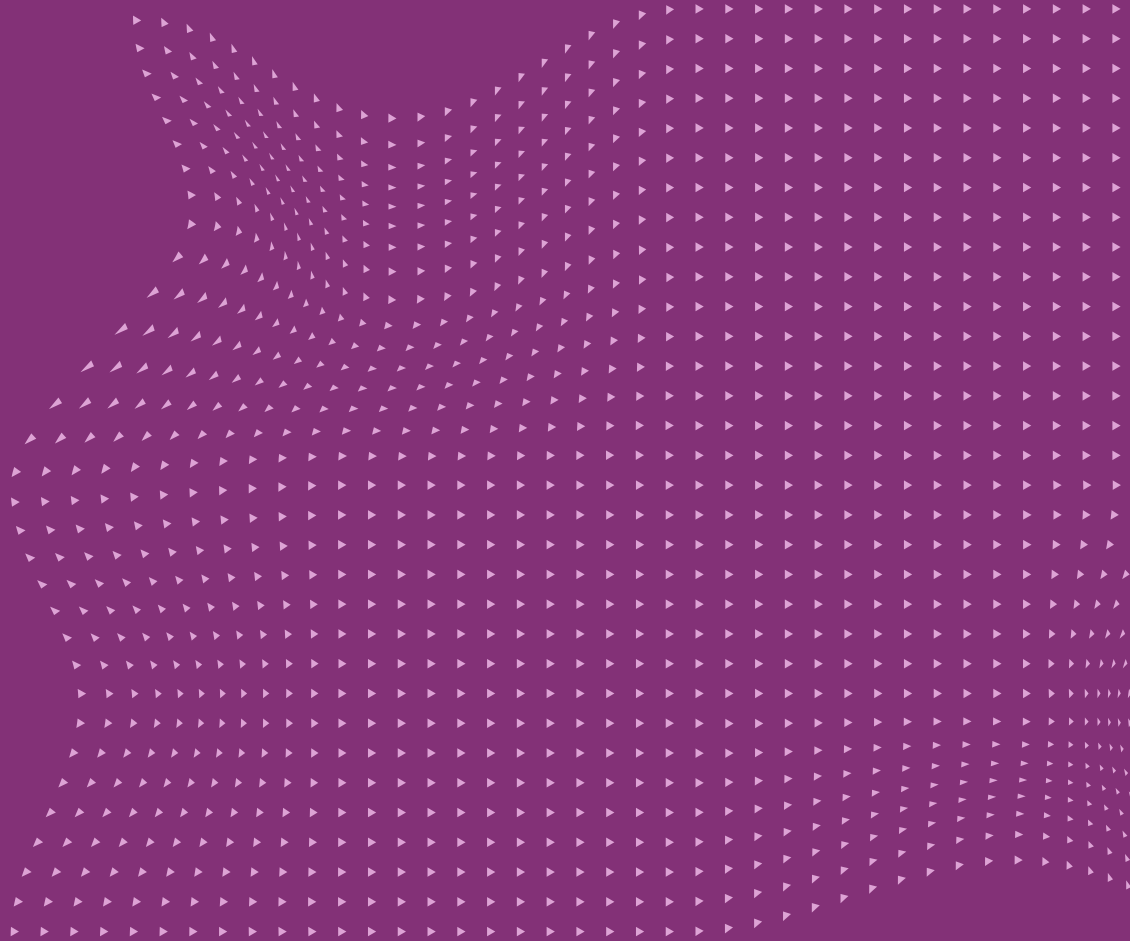

Steps to Retrofit Answer

- 1 Determine Answer spine type – panel, beam or fence. If panel, determine which style of panel trim – thin, square or oval.



Panel



Beam



Fence



Thin Trim



Square Trim



Oval Trim

- 2 Determine starting height and overall height desired/possible.

- Maximum overall height on panel is 90”H.
- Maximum overall height on beam is 48”H.
- Maximum overall height on fence is 48”H.

- 3 Determine materials desired (if options) – fabric, glass, other.

- 4 Once you have selected, place your order.

RESOURCES

[Answer Beam and Fence Spec Guide](#)
Beam Screens pg. 67
Fence Screens pg. 375

[Answer Solutions Spec Guide](#)
Screens SOL pg. 247
Specifying Screens pg. 587

Answer Panel with Recessed Frameless Glass

Works on Answer panels with thin trim

Dimensions Width: 24" - 96"
Height: 6", 12" and 18"

Material Glass – clear or frosted

Installation Medium complexity

List price \$755 – 12"H x 72"W, clear glass

RESOURCES

[Answer Panel Product Page](#)



Application Tips:

- Available **only** for Answer panel with thin trim.
- Specified as a kit that includes top cap, supports and glass.
- Option to omit glass' if other material is desired (e.g. acrylic).
- Can be added to an existing panel without removing skins.
- Single piece of glass can span over multiple inline panels.

Answer Panel with Frameless Glass with Clips

Works on Answer panels with thin trim or square trim

Dimensions Width: 24" - 96"
Height: 12"

Material Glass – clear or frosted

Installation Medium complexity

List price \$755 – 12"H x 72"W, clear glass, thin trim
\$831 – 12"H x 72"W, clear glass, square trim

RESOURCES

[Answer Panel Product Page](#)



Application Tips:

- Available **only** for Answer panel with thin trim or square trim.
- Specified as a kit that includes top cap, supports and glass.
- Option to omit glass' if other material is desired (e.g. acrylic).
- Can be added to an existing panel without removing skins.
- Single piece of glass can span over multiple inline panels.

Answer Panel with Fabric Screens

Works on	Answer panels with thin trim
Dimensions	Width: 24" - 96" Height: 13.5" and 19.5"
Material	Fabric, <i>*Bleach cleanable available</i>
Installation	Medium complexity
List price	\$562 – 19.5"H x 48"W, Sarto \$745 – 19.5"H x 48"W, Universal

RESOURCES

[Answer Panel Product Page](#)



Sarto Screen



Universal Screen

Application Tips:

- Available **only** for Answer panel with thin trim.
- Specified as a kit that includes top cap, screen and screen supports/bayonets.
- Requires removal of top skin on one side of panel in order to assemble bayonet bracket to top horizontal bar.
- Cannot be used on panels with windows in the top position or panel segments where the horizontal bar is not in the top position.

Answer Panel with Boundary Screen

Works on	Answer panel with thin trim
Dimensions	Width: 25.5" – 75" (parametric every 1/16") Height: 30", 36", 42", 48" or 54"
Material	Laminate
Installation	Medium complexity
List price	\$1,685 – 48"H x 75"W single-sided, single connect, laminate

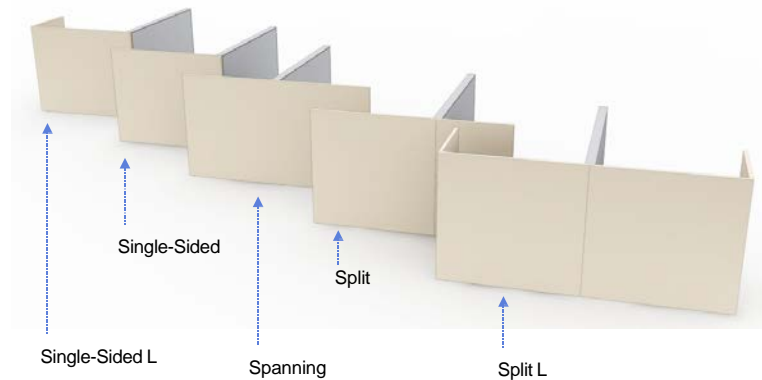

Application Tips:

- Applications available in single-sided, spanning, split, or L.
- Select from two connection types – single connect or dual connect.
- Boundary screens can only be used at the end of a run, but they do act as structural support for panels. See the specification guide for all application rules.

RESOURCES

[Answer Panel Product Page](#)

Stacking on Answer Panel

Works on	Answer panel
Dimensions	Width: 18" - 72" Height: 6", 12", 18" and 24"
Material	Fabric, Painted Steel, Markerboard, Laminate, Glass
Installation	Medium complexity
List price	\$634 – 12"H x 48"W stacked on single panel (includes inline junction, EOR junction, vertical trim, fabric skins)

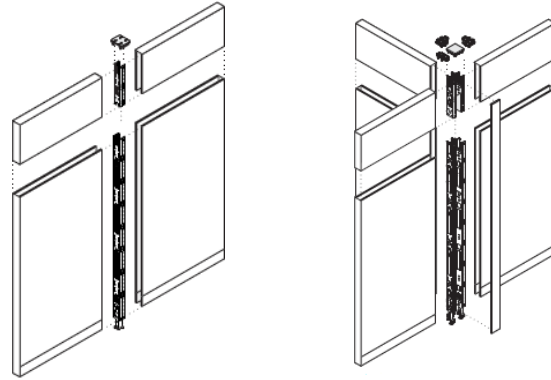

Application Tips:

- Requires stacking junctions, stacking horizontal frame package, trim and skins to complete application.
- Add a maximum of 2 stackers (36"H total) per base panel.
- Maximum height of base panel + stacker(s) is 90"H overall.
- Specify stacking junctions for appropriate trimstyle (thin, square or oval).

RESOURCES

[Answer Panel Product Page](#)

Answer Panel with Panel Top Screens

Works on Answer panels with square trim or oval trim

Dimensions Square Trim: 24" - 48"W x 12"H
Oval Trim: 30" - 48"W x 12"H

Material Plastic

Installation Low complexity

List price \$241 – 12"H x 48"W, square trim
\$250 – 12"H x 48"W, oval trim



Answer Panel with Square Trim



Answer Panel with Oval Trim

Application Tips:

- Available **only** for Answer panels with square trim or oval trim.
- Specified as a package that includes clips and screen.

Note: These clips can only be used with this screen.

- Screen is a very lightweight ribbed plastic material. Brackets are plastic.
- Brackets snap onto existing panel top caps. No tools or disassembly required.

RESOURCES

[Answer Panel Product Page](#)

Answer Fence with Frameless Glass Screen

Works on Answer fence

Dimensions Width: 24" - 96"
Height: 13.5" and 19.5"

Material Glass – clear or frosted

Installation Medium complexity

List price \$697 – 19.5"H x 48"W, clear glass



Application Tips:

- Specified as a kit that includes glass and supports.
- Requires removal of fence covers in order to assemble screen to the fence.

RESOURCES

[Answer Fence Product Page](#)

Answer Fence with Fabric Screens

Works on	Answer fence
-----------------	--------------

Dimensions	Width: 24" - 96" Height: 13.5" and 19.5"
-------------------	---

Material	Fabric, <i>*Bleach cleanable available</i>
-----------------	--

Installation	Medium complexity
---------------------	-------------------

List price	\$521 – 19.5"H x 48"W, Sarto \$704 – 19.5"H x 48"W, Universal
-------------------	--



Answer Fence with SartoScreen



Answer Fence with Universal Screen

Application Tips:

- Specified as a kit that includes screen and supports/bayonets.
- Requires removal of fence covers in order to assemble bayonet bracket to horizontal bar.

RESOURCES

[Answer Fence Product Page](#)

Answer Fence with Boundary Screen

Works on Answer fence

Dimensions Width 27" – 75" (parametric every 1/16")
Height 42", 48"

Material Laminate

Installation Medium complexity

List price \$853 – 48"H x 39"W, single-sided, single connect, laminate

RESOURCES

[Answer Fence Product Page](#)

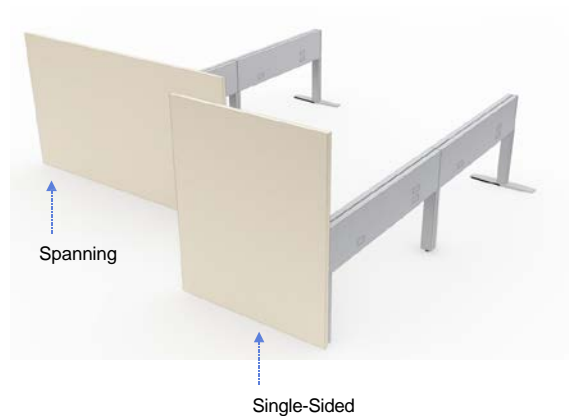

Application Tips:

- Applications available in spanning or single-sided.
- Note that available widths vary by application type.
- Boundary screens can only be used at the end of a run, but they do act as structural support for fences. See the specification guide for all application rules.

Answer Beam with Fabric Screens

Works on	Answer beam
-----------------	-------------

Dimensions	Width: 24" - 96" Height: 13.5" and 19.5"
-------------------	---

Material	Fabric, <i>*Bleach cleanable available</i>
-----------------	--

Installation	Low complexity
---------------------	----------------

List price	\$521 – 19.5"H x 48"W, Sarto \$704 – 19.5"H x 48"W, Universal
-------------------	--



Answer Beam with SartoScreen



Answer Beam with Universal Screen

Application Tips:

- Specified as a kit that includes screen and supports.
- Can be placed anywhere along beam rail.

RESOURCES

[Answer Beam Product Page](#)

Answer Beam with Boundary Screen (EOR)

Works on	Answer beam
-----------------	-------------

Dimensions	Width: 25.5" – 75" (parametric every 1/16") Height: 28.5", 42", 48"
-------------------	--

Material	Laminate
-----------------	----------

Installation	Medium complexity
---------------------	-------------------

List price	\$1,685 – 48"H x 75"W single-sided, single connect, laminate
-------------------	--

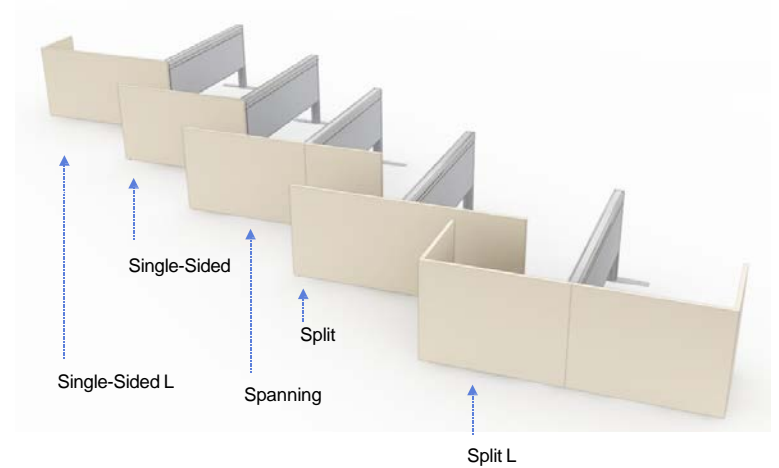

Application Tips:

- Applications available in single-sided, spanning, split, or L.
- Note that available widths vary by application type.
- Boundary screens can only be used at the end of a run, but they do act as structural support for beams. See the specification guide for all application rules.

RESOURCES

[Answer Beam Product Page](#)

Answer Beam with Boundary Screen (Inline)

Works on	Answer beam
Dimensions	Width: 24" – 75" (parametric every 1/16") Height: 28.5", 42" and 48"
Material	Laminate
Installation	Medium complexity
List price	\$1,685 – 48"H x 72"W centered, single-sided, singleconnect, laminate

RESOURCES

[Answer Beam Product Page](#)

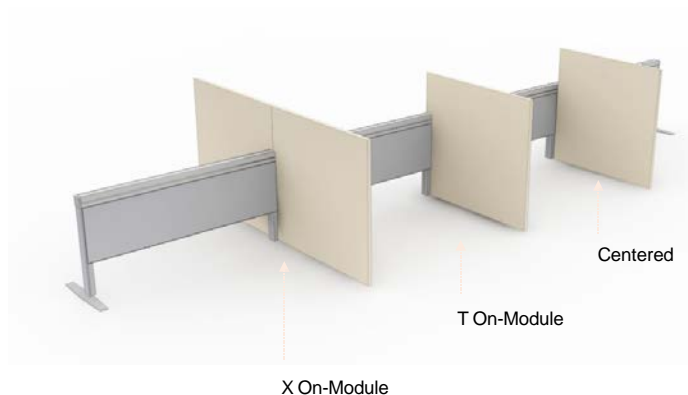

Application Tips:

- Applications available in on-module (X or T) or centered.
- Note that available widths and heights vary by application type.
- These boundary screens are used at inline connections to provide separation between workstations.
- On-module inline boundary screens require an on-module inline junction.
- Centered inline boundary screens connect to an existing inline junction.

Retrofitting Workstations with Screens

Freestanding Screens

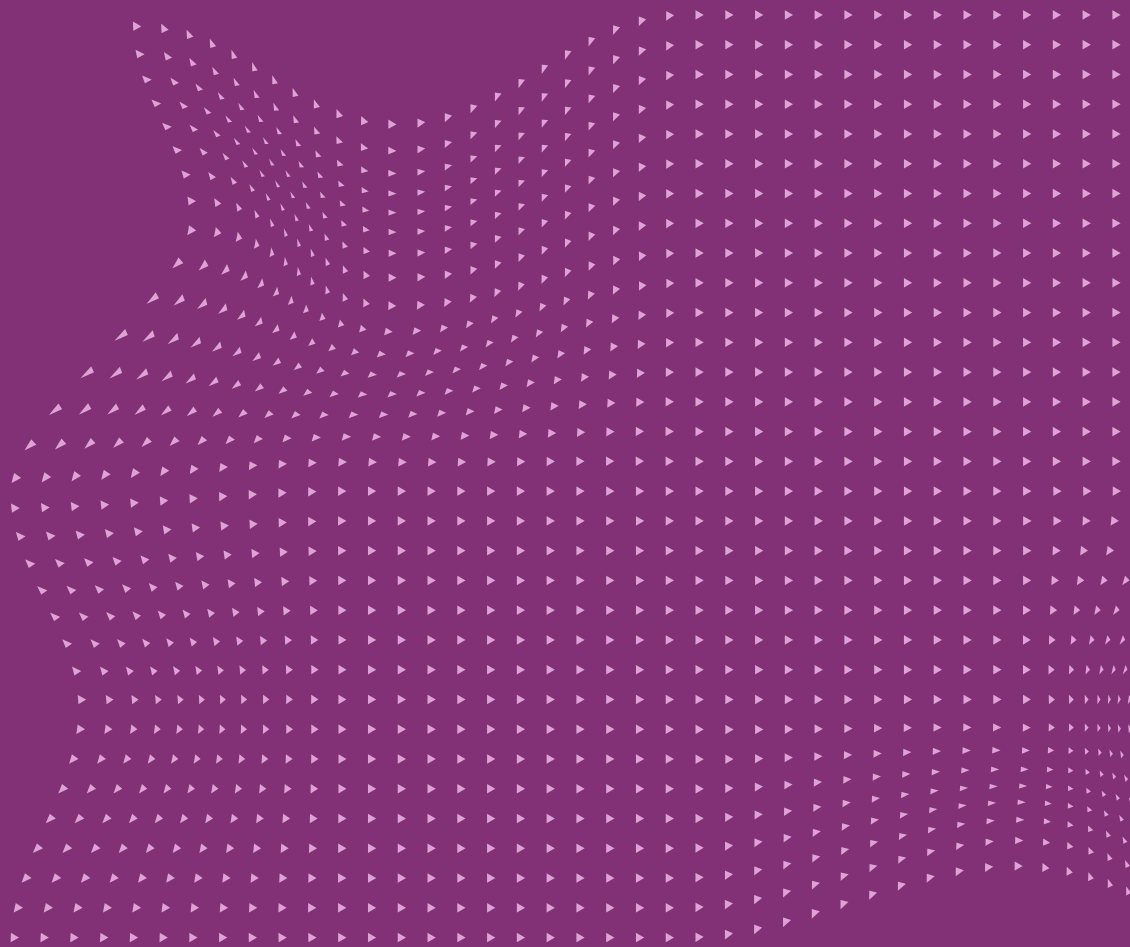

Considerations for Adding Freestanding Screens

- Provide added shielding around or in-between individual workstations.
- Add to shared, ancillary spaces to provide boundary and division.
- Use alone or group together to form large partitions and/or define spaces.
- Use to guide new behaviors and workplace distancing protocols.
- Plan for how freestanding screens could be reused in the future as your workplace or shielding needs change.



Flex Freestanding Screen shielding individual workstation.



Demonstration of future use by adding Flex Wall Rail.

RESOURCES

[Steelcase Flex
Collection Specification Guide](#)
(Freestanding Screens pg. 17
+ 41)

[Freestanding Screen Gallery](#)

Flex Freestanding Screens

Works in	Any environment
Dimensions	Rectangle Screen: Width: 24" (NEW), 30" (NEW) or 36" W Height: 47" or 71" Angled Screen: 47"W x 47"H
Material	Fabric, <i>*Bleach cleanable available</i>
Installation	Low complexity
List price	\$725 – 35.5"W x 47"H rectangle \$850 – 35.5"W x 71"H rectangle \$785 – 47"W x 47"H angled

RESOURCES

[Steelcase Flex Screens Product Page](#)



Flex Freestanding Screens

Application Tips:

- Use the tall rectangle to provide instant, temporary and user-moveable boundary.
- Magnet edge allows for 360° of attachment to other Flex freestanding screens and steel surfaces.
- Use contrasting fabric to designate areas or indicate protocols in the workspace.
- Use to shield today and collaborate tomorrow. Flex freestanding screens are pin-tackable and can be used in the Flex system of solutions (wall rail, carts, etc.) for future flexibility.
- Use the new rectangle screen widths to wrap height-adjustable desking on both sides and back.

Flex Markerboard + Stand

Works in	Any environment
Dimensions	Width: 35.5" W Height: 47" or 71"
Material	Markerboard
Installation	Low complexity
List price	\$635 – 35.5"W x 47"H rectangle \$675 – 35.5"W x 71"H rectangle \$2075 – 35.5"W x 47"H rectangle (pkg of 4) \$2225 – 35.5"W x 71"H rectangle (pkg of 4) \$560 – 16" DIA x 38"H stand

RESOURCES

[Steelcase Markerboard Solutions Product Page](#)



Flex Markerboard + Stand

Application Tips:

- Use the tall rectangle to provide instant, temporary and user-moveable boundary.
- Use to separate desks or to shield in shared collaborative spaces.
- Markerboard surface can be wiped down with isopropyl alcohol or standard disinfectants.
- Tip: Markerboard pricing is lower per screen when you purchase with the package style number.
- Use to shield today and collaborate tomorrow. Flex markerboards can be used in the Flex system of solutions (wall rail, carts, etc.) for future flexibility.

Groupwork Screens

Works in	Any environment
Dimensions	Width: 24", 30", 36", 42" or 48" Height: 54" or 66"
Material	Frame: 7207 Black, 4799 Platinum or 4798 Sterling Screen Panel: Fabric, 2977 White Markerboard Laminate or e3 CeramicSteel 7655 High Gloss White
Installation	Low complexity
List price	\$884 – 36"x66" Fabric \$884 – 36"x66" Markerboard Laminate \$949 – 36"x66" e3 CeramicSteel

RESOURCES

[Groupwork Screens + Whiteboards Product Page](#)



Groupwork Screens

Application Tips:

- Place in between workstations or at the end of a run for easy and functional lateral separation.
- Standard four locking casters allow for easy movement and day two flexibility.
- Levelers can be specified for applications where screens are desired to stay in place.
- The nonporous surface on CeramicSteel is bacteria resistant and withstands standard and highly potent cleaning solutions.
- Use to shield today and collaborate tomorrow. Groupwork screens are available in pin-tackable fabric or markerboard finishes which can be moved and repurposed as your workplace changes.

Steelcase Health Separation Screens

Works in Any environment

Dimensions Width: 48" or 72"
Height: 72"

Material Frame: Platinum Metallic (4799)
Screen Panel: Smooth Clear Plastic or Smooth White Opaque Plastic

Installation Low complexity

List price Starting at \$916

RESOURCES

[Separation Screens Product Page](#)



Separation Screen
72"W x 72"H



Separation Screen
48"W x 72"H

Application Tips:

- Works well in non-healthcare applications such as retail, banking and essential public domains.
- Use alone or group together to form larger partitions.
- Screen panels arrive fully assembled and are mounted offset of frames to allow for easy cleaning.
- Available with optional cutouts so users can conveniently transfer documents and small items.

Appendix

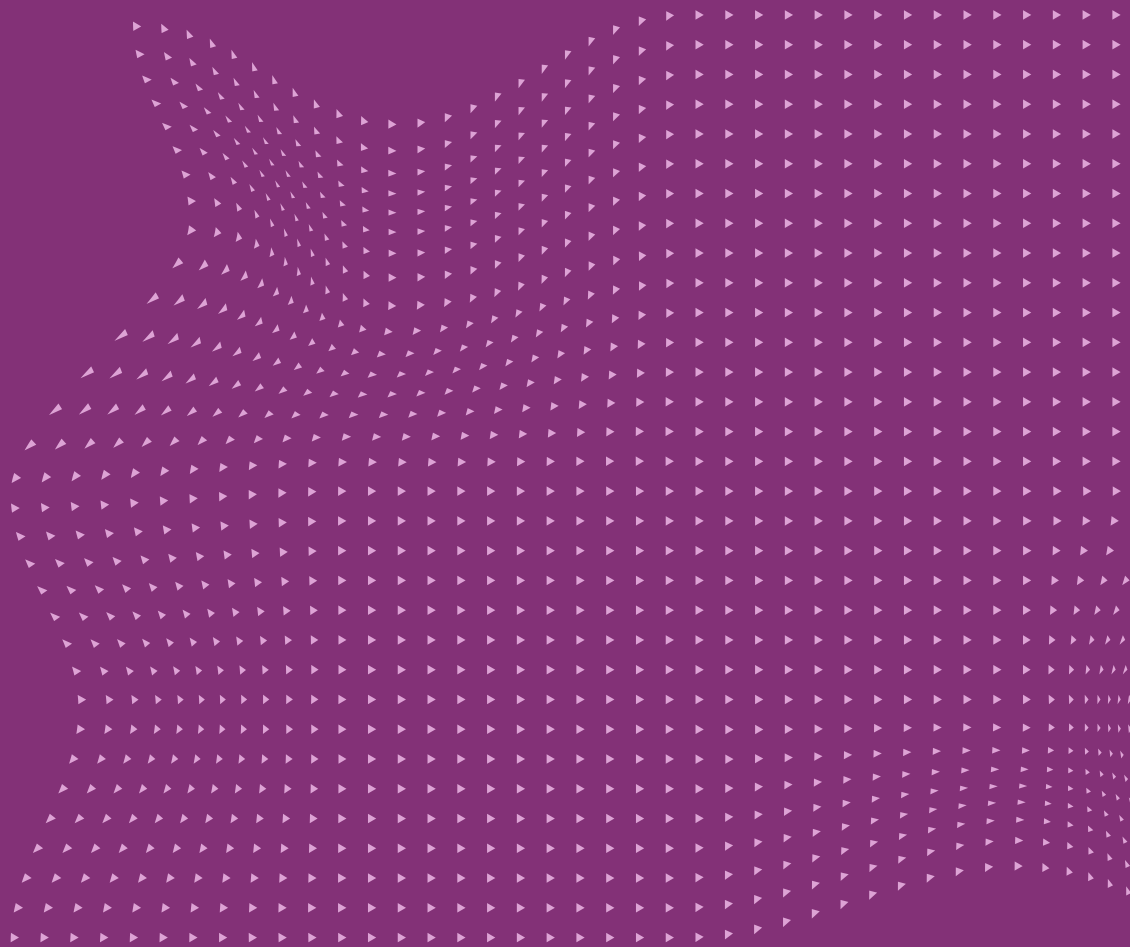

Materiality

The cleanability of interior surfaces is now more important than ever. Without sacrificing aesthetics, intentional material decisions can help promote a healthy, highly cleanable and beautiful environment. While deciding what's right for you, we recommend that you consider the information and in-depth resources linked below. **This information and much more can be found in [Cleaning Your Steelcase Products](#).**

Antimicrobial Technology Used in Textiles

"Microbial" is a general term used to describe several types of micro-organisms, including bacteria and fungi (viruses are not microbial as they are not technically alive). Generally, the use of the term "antimicrobial" describes action against bacteria and fungi, but not viruses. Findings by the Centers for Disease Control and Prevention (CDC) found no evidence to suggest that use of products treated with antimicrobial chemicals would prevent disease.

Recognizing that some customers do still require antimicrobial additives, Steelcase has kept options available for high-touch surfaces such as seating fabrics and worksurface laminates through our COM process.

Fabrics with antimicrobial treatments cannot state or imply any human health or wellbeing benefits in marketing materials, to avoid misrepresentation and/or violating laws (EPA guidance; FIFRA registration). **There are currently no commercially-available antimicrobial fabric treatments that can claim a human health benefit.**

Bleach-Cleanable

Hard surfaces are not the only option for cleanability.

Many Steelcase and Designtex fabrics are safe to use with a 10:1 water/bleach spray, but not all. For a list of these materials, see the Finish Library and filter by "[bleach cleanable](#)."

RESOURCES

[Cleaning Your Steelcase Products
Surface Materials Reference Manual](#)
[Designtex Cleaning Manual](#)

Available Products List – Screens for Desking and Benching

Product	Style Number	Works On	Height	Back	Side Screen	Material	Application Considerations	Installation Complexity	List Price 60"W
Worksurface-Mounted									
Sarto	PSPS	Ology Desk and Bench, Migration, Migration SE Desk and Bench, Flex, FrameOne, Series 5 worksurfaces, Elective Elements worksurfaces, Universal Tables, and Universal panel-mount worksurfaces	13.5" or 19.5"	Yes	Yes	Fabric	Pinch Point	Medium	\$339, \$431
Sarto Curved	PHSCRN		18"	Yes	20"	Fabric	Pinch Point	Medium	\$500 each
Sarto Privacy/Modesty	PSPM		13.5" (24")	Yes	Yes	Fabric	Pinch Point	Medium	\$466
Sarto 24" Special	PSPS	Ology Desk and Bench, Migration, Migration SE Desk and Bench, Flex, FrameOne, Series 5 worksurfaces, Elective Elements worksurfaces	24"	Yes	Yes	Fabric	Pinch Point	Medium	Coming Soon
Universal	UFPS	Ology Desk and Bench, Migration, Migration SE Desk and Bench, Flex, Airtouch, FrameOne, Series 5 worksurfaces, Elective Elements, Universal Tables, and Universal panel mount worksurfaces.	13.5" or 19.5"	Yes	Yes	Fabric	Pinch Point	Medium	\$457, \$582
Universal Privacy/Modesty	UFPM		13.5" or 19.5" (26")	Yes	Yes	Fabric	Pinch Point	Medium	\$580
Acrylic	AP58	Ology, Flex, Migration and Migration SE, Series 5, Airtouch	19" (22")	Yes	No	Acrylic	1" gap	Medium	\$512
eSpecials	FMSSG FMSSF	3/4", 1-3/16" and 1-1/2" thick worksurfaces (FrameOne, Universal, Ology, Flex, Migration, Migration SE, c:scape and Elective Elements worksurfaces)	12" or 19.5"	No	Yes	Glass, Fabric	No Pinch Point	Medium	\$694 \$818
Health Desktop Separation Screen	Coming Soon	3/4" to 1-1/2" thick worksurfaces	30", 42"	Yes	Yes	Plastic	No Pinch Point	Low	Coming Soon
AMQ 3F Screens	Multiple styles, see Open Place Pricebook	1/2" to -5/8" thick worksurfaces	18", 23", and 28"	Yes	Yes	PET	Pinch Point	Low	\$270 (linear) \$60 (brackets)
Boundary Screens	OLBBSD OLBBSS FMDUALSPN FMDUALSPT	Ology Bench, FrameOne	28.5", 42", 48"	End of run screen attaches to bench crosstube or legs		Laminate, Veneer	Overhangs	Medium	\$875 (Ology Bench) \$886 (FrameOne)

Available Products List – Screens for Answer Panel, Fence and Beam

Product	Screen	Works On	Dimensions	Material	Installation Complexity	List Price 60"W
Answer	Recessed Frameless Glass	Answer panels with thin trim	Width 24" - 96" Height 6", 12" and 18"	Glass	Medium	\$755 – 12"H x 72"W, clear glass
	Frameless Glass with Clips	Answer panels with thin trim or square trim	Width 24" - 96" Height 12"	Glass	Medium	\$755 – 12"H x 72"W, clear glass, thin trim \$831 – 12"H x 72"W, clear glass, square trim
	Answer Panel Fabric Screens (Sarto, Universal)	Answer panels with thin trim	Width 24" - 96" Height 13.5" and 19.5"	Fabric	Medium	\$562 – 19.5"H x 48"W, Sarto \$745 – 19.5"H x 48"W, Universal
Answer Panel	Answer Panel with Boundary Screen	Answer panels with thin trim	Width 25.5" – 75" (parametric every 1/16") Height 30", 36", 42", 48", 54"	Laminate	Medium	\$1,685 – 48"Hx75"W single-sided, single connect, laminate
	Stacking on Answer Panel	Answer panel	Widths: 18"-72" Heights: 6", 12", 18", 24"	Fabric, Painted Steel, Markerboard, Laminate, Glass	Medium	\$634 – 12"Hx48"W stacked on single panel (includes inline junction, EOR junction, vertical trim, fabric skins)
	Answer Panel Panel Top Screens	Answer panels with square trim or oval trim	Square Trim: 24" - 48"W x 12"H Oval Trim: 30" - 48"W x 12"H	Plastic	Low	\$241 – 12"H x 48"W, square trim \$250 – 12"H x 48"W, oval trim
	Frameless Glass	Answer Fence	Width 24" - 96" Height 13.5" and 19.5"	Glass	Medium	\$697 – 19.5"H x 48"W, clear glass
Answer Fence	Answer Fence Fabric Screens (Sarto, Universal)	Answer Fence	Width 24" - 96" Height 13.5" and 19.5"	Fabric	Medium	\$521 – 19.5"H x 48"W, Sarto \$704 – 19.5"H x 48"W, Universal
	Answer Fence with Boundary Screen	Answer Fence	Width 27" – 75" (parametric every 1/16") Height 42", 48"	Laminate	Medium	\$853 – 48"H x 39"W, single-sided, single connect, laminate
	Answer Beam Fabric Screens (Sarto, Universal)	Answer Beam	Width 24" - 96" Height 13.5" and 19.5"	Fabric	Low	\$521 – 19.5"H x 48"W, Sarto \$704 – 19.5"H x 48"W, Universal
Answer Beam	Answer Beam with Boundary Screen (EOR)	Answer Beam	Width 25.5" – 75" (parametric every 1/16") Height 28.5", 42", 48"	Laminate	Medium	\$1,685 – 48"H x 75"W single-sided, single connect, laminate
	Answer Beam with Boundary Screen (Inline)	Answer Beam	Width 24" – 75" (parametric every 1/16") Height 28.5", 42", 48"	Laminate	Medium	\$1,685 – 48"H x 72"W centered, single-sided, single connect, laminate

Available Products List – Freestanding Screens

Product	Style Number	Works On	Height	Material	Application Considerations	Installation Complexity	List Price
Freestanding							
Flex Freestanding	FLXFSRQ	Anywhere	47", 71"	Fabric		Low	\$850
Flex Markerboards	FLXMB FLXMB4	Anywhere	47", 71"	Markerboard		Low	\$675 \$2,225
Flex Stand	FLXSTAND	Anywhere	38"	Plastic		Low	\$560
Groupwork Screen	TS4S**54 TS4S**66	Anywhere	54", 66"	Fabric, Laminate, e3 CeramicSteel		Low	\$884
Health Separation Screen	HSDSF4872	Anywhere	72"	Plastic		Low	\$916

Supporting Resources

DESKING

[Height Adjustable Desking Specification Guide](#)
[Height Adjustable Desking Solutions Comparison](#)
[Ology Desk Brochure](#)
[Migration Desk Brochure](#)
[Migration SE Desk Cutsheet](#)

BENCHING

[Benching Specification Guide](#)
[Ology Bench Brochure](#)
[Migration SE Bench Cutsheet](#)
[FrameOne Brochure](#)

SCREENS

[Steelcase Flex Collection Specification Guide](#)
[Steelcase Flex Collection Brochure](#)
[Height Adjustable Desking Specification Guide](#)
[Universal Screens Brochure](#)
[Sarto Screens Cutsheet](#)
[Separation Screen Cutsheet](#)

PANELS

[Answer Specification Guide](#)
[Answer Brochure](#)
[Answer Panel Brochure](#)
[Answer Panel with Universal Fence Screen Overview](#)
[Answer Lookbook](#)

MATERIALITY + CLEANABILITY

[Cleaning Your Steelcase Products](#)
[Surface Materials Reference Manual](#)
[DesignTex Cleaning Manual](#)

OTHER

[Navigating What's Next: The Post-Covid Workplace](#)

Flex Image Gallery

Examples of Flex Freestanding Screen shielding individual workstations.



Flex Image Gallery

Examples of Flex Freestanding Screen and Markerboard shielding shared ancillary space.



Flex Image Gallery

Examples of Flex Freestanding Screen future use, shielding team space with multi-purpose use as tackable surface for collaboration.



FORWARD
SPACE.

Steelcase®

[Forwardspace.com/screens](https://forwardspace.com/screens)



CHI



MKE

Chicago, IL

222 W. Merchandise Mart Plaza
Suite # 614
Chicago, IL 60654
P. (312) 942-1100
F. (312) 942-9840

Oak Brook, IL

1111 W. 22nd Street, Suite 150
Oak Brook, Illinois 60523
P. (630) 589-5500
F. (630) 589-5637

Lake Forest, IL

13820 W. Business Center Drive, Unit C
Lake Forest, Illinois 60045
P. (312) 942-1100

Milwaukee, WI

1300 N 7th Street
Suite 100
Milwaukee, Wisconsin 53205
P. 414.377.7170